

MORSETTIERA 82 x 52 3-6 PERNI M8

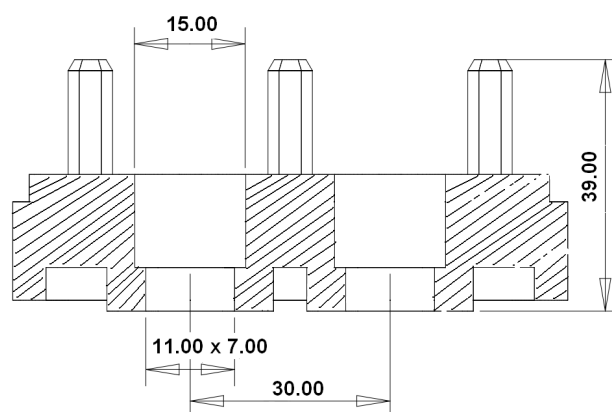
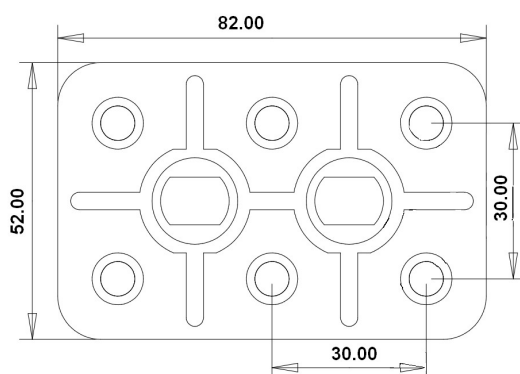
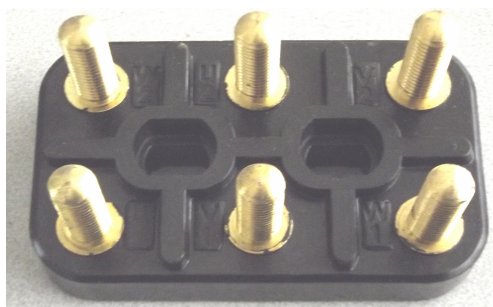

MORSETTIERA REALIZZATA IN RESINA FENOLICA CERTIFICATA U.L.

PERNO M8 IN OTTONE OPPURE IN ACCIAIO ZINCATO

DADO M8 UNI 5589

RONDELLA FORO D.8

PIASTRINA DI COLLEGAMENTO MIS.8x30